



## 概述 Overview

固态继电器是以电力半导体器件为主功率器件的工业控制电器,它与传统的电磁接触式工业控制器相比较,更符合电力电气设备朝着高性能,智能化,数字化,系统化及绿色化发展的要求。

固态继电器按照开关方式分为过零零通型和随机导通型。当输入控制信号后,随机型能立即导通,过零型要等到负载电压过零区域才能导通。撤销控制信号后,都在小于维持电流时关断。过零型有可能造成最大半个周期的延时,却减小了对负载的冲击和射频干扰,是理想的开关器件。随机性特点是反应快,适合应用于调光调温等阻性负载和部分感性负载场合。

当CSR由导通到关断时,由于电流电压的相位不一致,将产生一个很大的电压上升率(dv/dt)在双向可控硅上,如上升率超过双向可控硅的换向dv/dt指标(标准为300V/us),将导致延时关断甚至失败。由2只单向可控硅反并联构成的增强型CSR比普通由1只双向可控硅构成的CSR的换向dv/dt有很大的提高(dv/dt值为500V/us)。因此在感性负载或容性负载领域建议选用增强型CSR。我司的固态继电器均为增强型。

固态调压器由可控硅开关电路、阻容移相电路。滞后电路和过压吸收电路等以模块的外形组成。使用时只需外接一个电位器,就可以用来实现交流功率调节。在许多场合可以取代笨重的接触式调压器,广泛应用于包装机械、纺织机械、舞台照明电源、电压、温度、亮度、速度等模拟调节。

Solid State Relay(CSR) is industrial control appliances which use power semiconductor devices for main control part, compare with traditional magnetic contact industrial controllers, it is more high-powered, intelligent, digital, systematic and green development.

according switch mode CSR have zero-cross and random type. When the input control signal, random type conduction immediately, zero cross type need load voltage turn to zero region just can conduction. Revocation of the control signal,all can cut off when less than maintenance current. zero cross type may cause the maximum half-cycle delay, but reduces the impact of the load and radiofrequency interference, is the ideal switching devices.Random type fast response,suitable for dimmer,thermostats resistive loads and some inductive load applications.

When the CSR turn off, if in the phase current and voltage have different, will have a large rise rate (dv/dt) on the triac, such as dv/dt higher than Triac standatr (300V/us), will result in delay shutdown even failure. use anti-parallel thyristor's CSR(powerful type) will been greatly improved at dv/dt(dv / dt is 500V/us). Therefore, in the field of capacitive load or inductive load, suggest the use powerful type CSR. CNTD's CSR are all powerful type.

Solid-state voltage regulator consists of thyristor switching circuit, resistance-capacitance phase shifting circuit,lag circuit and over-voltage absorption circuit.The use of only one external potentiometer can be used to achieve AC power regulation.In many occasions can replace the heavy contact voltage lighting power supply,voltage,temperature,brightness, speed and other analog adjustment.

## 应用 Applications

- 交流直流开关和温度控制
- AC DC switch & Temp control
- 自动化控制
- Automate Control
- 数控机械
- CNC machinery
- 包装机械
- Packaging machinery
- 纺织机械
- Textile machinery
- 玻璃机械
- Glass machinery
- 塑料机械
- Plastic machinery

## 特点 Features

- 电流: 0.5A 400A
- Current:0.5A~400A
- 电压: 12V 680V
- Voltage:12V~680V
- 通用安装尺寸
- General Install Size
- 真空焊接技术
- Vacuum Weld Technics
- LED指示灯显示“ON”或“OFF”
- Led indicator showing “ON” or “OFF”
- 保护面板
- Protect Panel
- IEC标准
- IEC standard
- 输入输出类型可选择 DC / AC AC / AC DC / DC
- Input & output type could chose DC/AC AC/AC DC/DC



■ 灰色标准型 Gray



■ 浅绿色高端型 Light green

## 型号说明 Model Number Structure



- 1 CSR=昌得单相固态继电器 CSR=CNTD Single Phase Solid State Relay  
CTR=昌得三相固态继电器 CTR=CNTD Three Phase Solid State Relay
- 2 无=浅绿色高端型 None= Improve Design Type(Light Green)  
E=灰色标准型 E=Standard Economic Type(Gray)
- 3 额定电流 Rated Operation Current
- 4 控制和负载电压类型 Control & Load voltgge type  
DA=DC(4-32V)AC(24-380V) AA=AC(80-250V)AC(24-380V)  
DD=DC(4-32V)DC(12-240V) VA=Voltage regulator调压器(24 380VAC)
- 5 常规过零触发型 None=Zero Cross Trigger  
随机触发型 R=Radom Switch

1. CSR-D(DC TO AC) Application Circuit  
DA应用电路

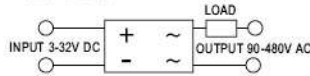

2. CSR-A(AC TO AC) Application Circuit  
AA应用电路

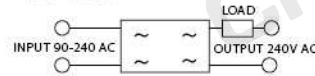

3. CSR-DD(DC to DC) Application Circuit  
DD应用电路

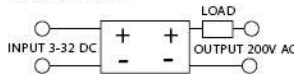

4. CSR-V(voltage regulator) Application Circuit  
VA应用电路

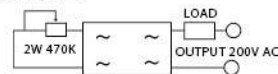

5. Motor positive and reverse Application Circuit  
电机正反转应用电路

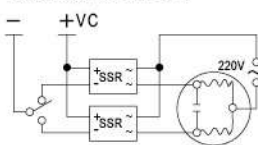

6. 3phase CSR Load control Connect  
三相负载控制连接

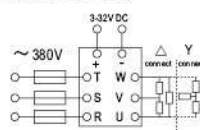

7. 3phase Motor positive and reverse  
三相电机正反转电路

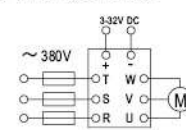

应用参数 Specification	输入 input parameter				输出 output parameter				安全负载 Safe Load			
	控制电压 Control Voltage	控制电流 Control Current	启动电流 Start Current	关闭电压 Close Voltage	工作电流 Operating Current	工作电压 Operating Voltage	绝缘电压 Insulate voltage	保护 Protection Over Voltage Over Current	阻性负载 Resistive Load	感性负载 Inductive Load		
CSR	DC/AC	4-32 V DC	<20mA	≥5mA	≤1.5V DC	10-100A	24-480 V AC	≥2500 VAC	RC MOV	Fast Fuse	60%	40%
	AC/AC	80-250 V AC	<30mA	≥5mA	≤10V AC	10-100A	24-480 V AC					
	Industry class	4-32 V DC	<20mA	≥5mA	≤1.5V DC	100-800A	24-480 V AC					
	DC/DC	3-32 V DC	<25mA	≥5mA	≤1.5V DC	10-40A	12-250 V DC					
CTR	4-32 V DC	<30mA	≥9mA	≤2.5V DC	10-120A	24-480 V AC	二极管保护 Diode	RC MOV	Fast Fuse			
固态调压器 Solid State Voltage Regulator	电位器 Potentiometer 500KΩ/1/4W				10-40A	10-250V AC		RC MOV	Fast Fuse			

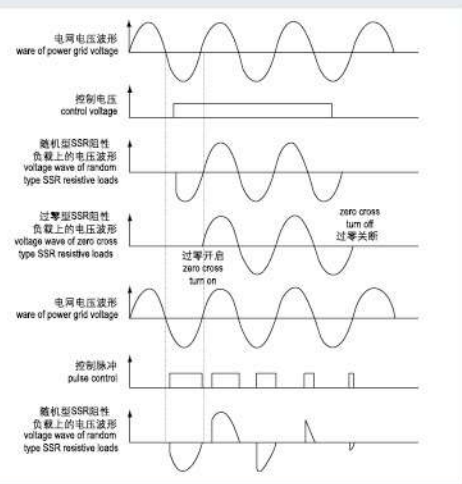

内置阻容吸收保护回路 RC: Built-in resistance capacity absorption circuit.  
外部并联压敏电阻 MOV: External shunt metal oxide varistor.

**使用注意事项 Notes**

1. 严禁短路负载，可以使用快速熔断器。Strictly prohibit for load short circuit.Can use fast fuse.
2. 长期工作不能超过额定值的70%。Ling time working current can't over 70% of the nominal value.
3. 散热器温度不能超过与75℃。Heatsink temperature can't over 75℃.
4. 用于感性负载，加压敏电阻保护更好。Use at inductive load area, adding varistor for protect is better.

**各种负载推荐值(常温) Recommended value of load type (Room temperature)**

负载类型 Load type	纯电阻 Pure Resistance	电热丝 Electric hot wire	白炽灯泡 Incandescent lamp	变压器 / 电磁铁 Transformer/ Electromagnet	单相交流电机 1 phase AC motor	三相交流电机 3 phase AC motor
负载值 value of load	100%	50-70%	35-50%	25-40%	12-24%	18-33%

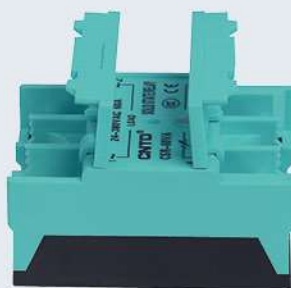

专利设计，采用一体式翻盖保护造型，操作方便，防护罩不易丢失。  
Patent design, using the coverprotection model, easy to operate



CSR-B01  
导轨卡件 CSR clamp



高品质螺丝，六角套筒或螺丝刀均可进行操作。一体式固定垫片，无接线端子的铜线也可直接使用。  
High quality screw, can operate by hexagonal sleeve or screwdriver. Integral fixed gasket, wire without terminal can also be used directly.

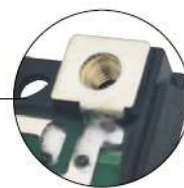

内部结构设计功率器件直接导通安装紫铜电极，过电流能力强。辅助铜卡件，螺纹精准并能辅助增强导电能力。  
Power device directly conducts with copper electrode, which has strong overcurrent ability. Brass fasteners with precise threads help to enhance conductivity.



SMT双面板全贴片工艺，视觉检查杜绝虚焊，双光耦控制+下限保护设计，精选进口电子元器件，优选美国Crydom和法国Celduc的驱动优势，抗干扰能力强，控制精准。  
SMT double panel full patch process, optimize the driving advantages of Crydom and Celcu, strong anti-interference ability, accurate control.



真空灌封进口透明硅凝胶，导热性能优越，绝缘特性强。多层密封设计，防水 防尘 抗盐雾，可在多种严苛环境下稳定使用。  
Transparent silicone gel has excellent thermal conductivity and strong insulation characteristics. Multi-layer sealing design, waterproof, dustproof and salt fog resistance, can be used stably in harsh environments.

**规格 Specifications**

型号 Model	CSR-DA		CSR-AA		CSR-VA	CSR-DD	CTR-DA	
	CSRE-DA		CSRE-AA		CSRE-VA	CSRE-DD	CTRE-DA	
负载电流 Operation Current	10A,25A,40A	60A,80A,100A	10A,25A,40A	60A,80A,100A	10A,25A,40A	10A,25A,40A	10A,25A,40A	60A,80A,100A,120A
负载电压 Operation Voltage	24-480V AC		24-480V AC		10-250V AC	12-250V DC	24-480V AC	
控制电压 Control Voltage	4-32V DC		80-250V AC		500KΩ/1/4W	3-32V DC	4-32V DC	
控制电流 Control Current	DC 3-25mA		AC ≤ 12mA		/	DC 3-25mA	DC 3-25mA	
V <sub>TM</sub> 通态压降	≤ 1.5V	≤ 1.5V	≤ 1.5V	≤ 1.5V	≤ 1.5V	≤ 2.3V	≤ 1.5V	≤ 1.5V
I <sub>RRM</sub> 漏电流	≤ 10mA	≤ 20mA	≤ 10mA	≤ 20mA	≤ 5mA	≤ 5mA	≤ 15mA	≤ 15mA
T <sub>Q</sub> 关断时间	≤ 10mS		≤ 10mS		≤ 10mS	≤ 10mS	≤ 10mS	
V <sub>iso</sub> 绝缘电压	2500V AC		2500V AC		2500V AC	2500V AC	2500V AC	
R <sub>iso</sub> 绝缘电阻	1000mΩ 500V DC		1000mΩ 500V DC		1000mΩ 500V DC	1000mΩ 500V DC	1000mΩ 500V DC	
T <sub>j</sub> 工作温度	-30~+80℃		-30~+80℃		-30~+80℃	-30~+80℃	-30~+80℃	
Weight 重量	90g	140g	90g	140g	90g	90g	350g	450g

外观和尺寸 Appearance and Dimension

CSR-DA



- | 产品型号 Model |
|------------|
| CSR-10DA   |
| CSR-25DA   |
| CSR-40DA   |
| CSR-60DA   |
| CSR-80DA   |
| CSR-100DA  |

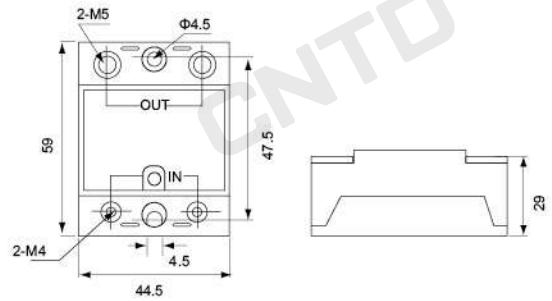

CSR-AA



- | 产品型号 Model |
|------------|
| CSR-10AA   |
| CSR-25AA   |
| CSR-40AA   |
| CSR-60AA   |
| CSR-80AA   |
| CSR-100AA  |

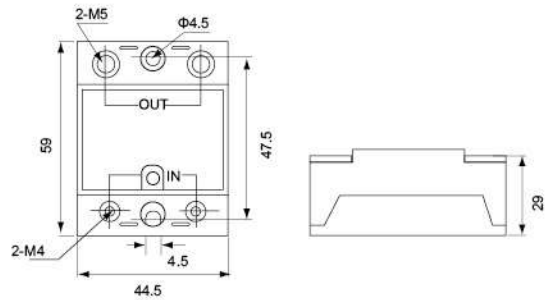

CSR-VA



- | 产品型号 Model |
|------------|
| CSR-10VA   |
| CSR-25VA   |
| CSR-40VA   |

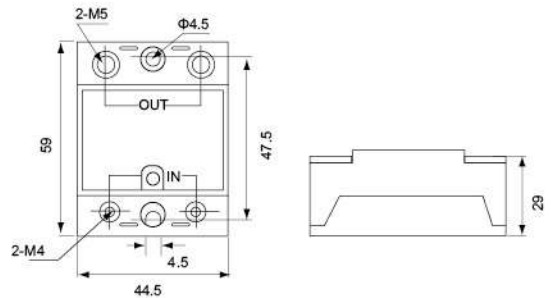

CSR-DD



- | 产品型号 Model |
|------------|
| CSR-10DD   |
| CSR-25DD   |
| CSR-40DD   |

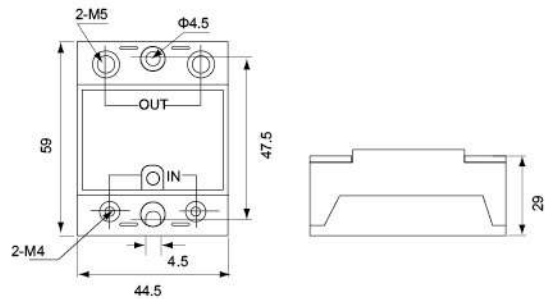

CTR-DA



- | 产品型号 Model |
|------------|
| CTR-10DA   |
| CTR-25DA   |
| CTR-40DA   |
| CTR-60DA   |
| CTR-80DA   |
| CTR-100DA  |
| CTR-120DA  |

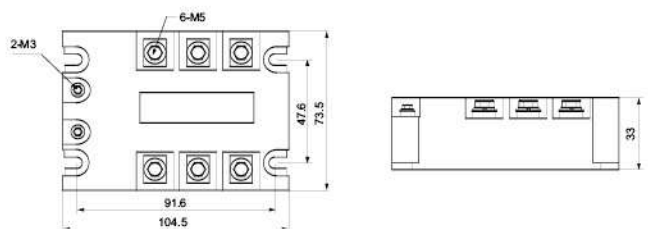

外观和尺寸 Appearance and Dimension

CSRE-DA



- 产品型号 Model
- CSRE-10DA
  - CSRE-25DA
  - CSRE-40DA
  - CSRE-60DA
  - CSRE-80DA
  - CSRE-100DA

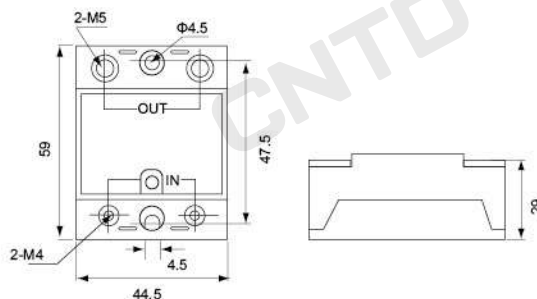

CSRE-AA



- 产品型号 Model
- CSRE-10AA
  - CSRE-25AA
  - CSRE-40AA
  - CSRE-60AA
  - CSRE-80AA
  - CSRE-100AA

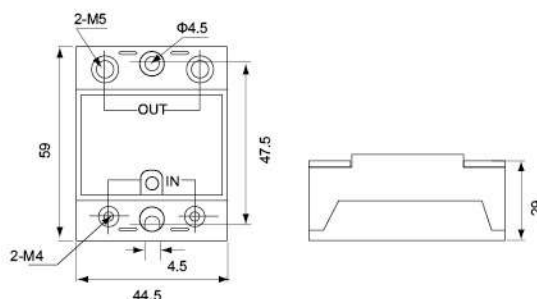

CSRE-VA



- 产品型号 Model
- CSRE-10VA
  - CSRE-25VA
  - CSRE-40VA

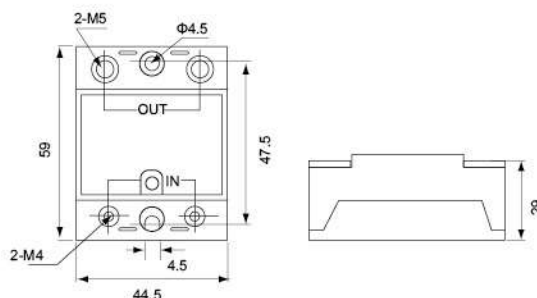

CSRE-DD



- 产品型号 Model
- CSRE-10DD
  - CSRE-25DD
  - CSRE-40DD

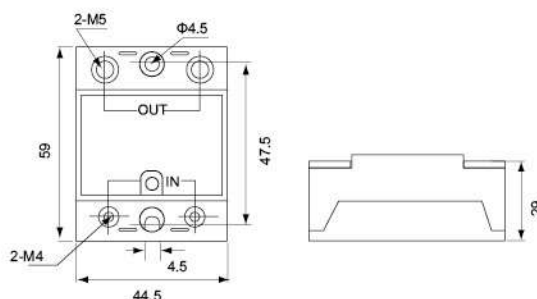

CTRE-DA



- 产品型号 Model
- CTRE-10DA
  - CTRE-25DA
  - CTRE-40DA
  - CTRE-60DA
  - CTRE-80DA
  - CTRE-100DA
  - CTRE-120DA

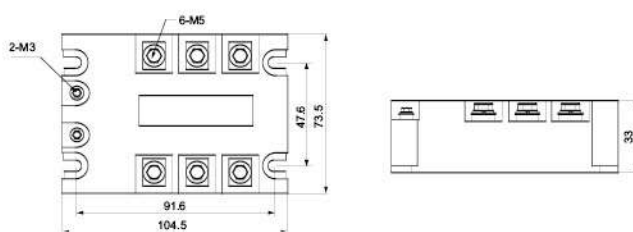

固态继电器耗散功率曲线图 Dissipative Power Curve of CSR

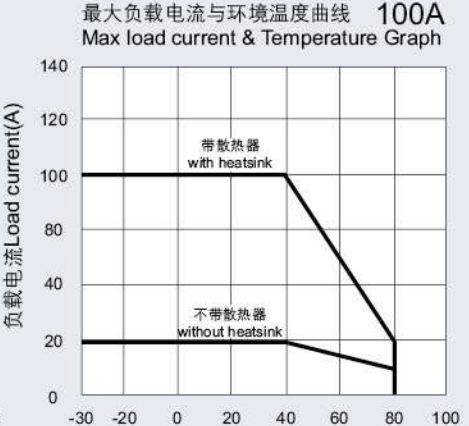
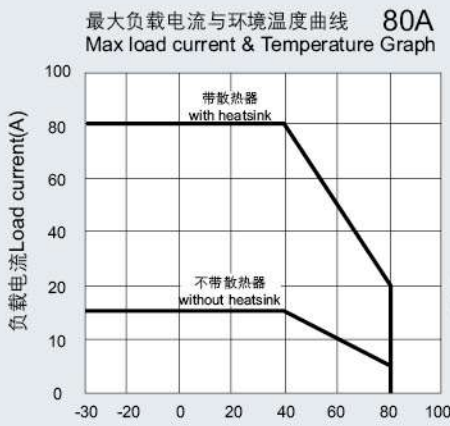
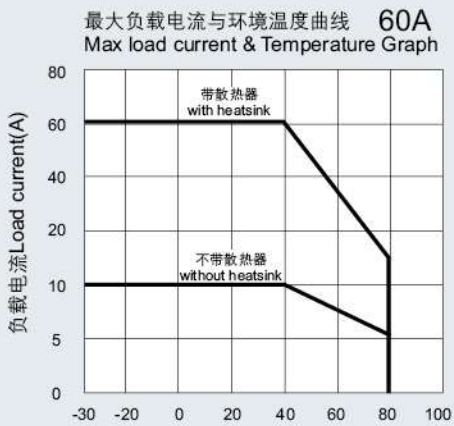
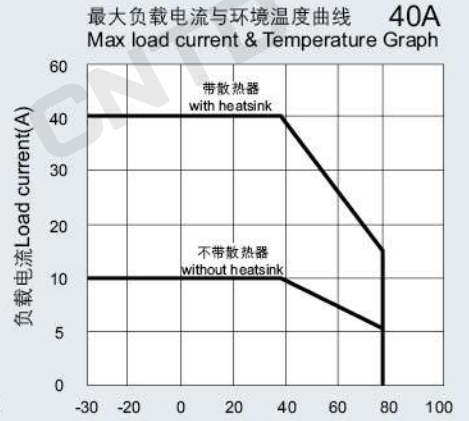
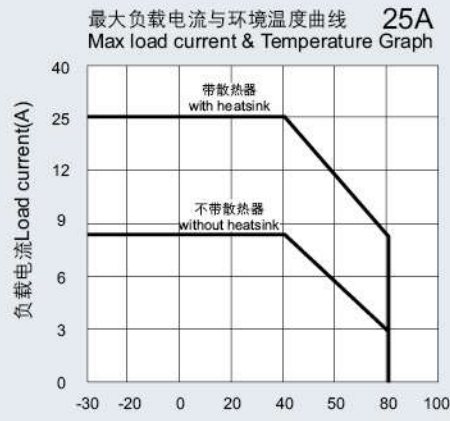
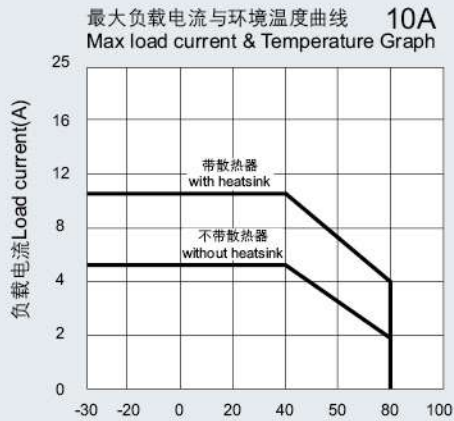

固态继电器用散热器 State Relay Heatsink

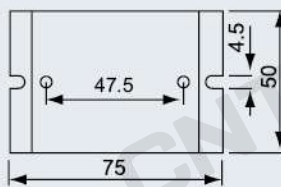
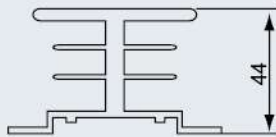

CSR-A01  
(For CSR10A-40A)

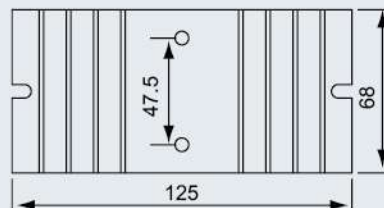
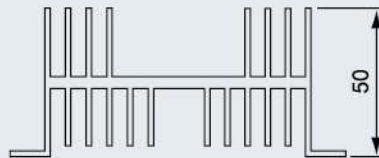

CSR-A02  
(For CSR60A-100A)

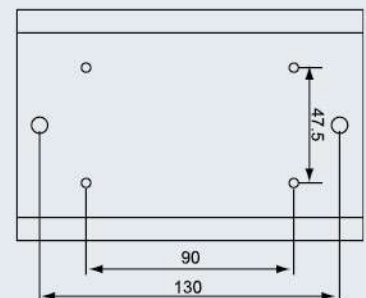
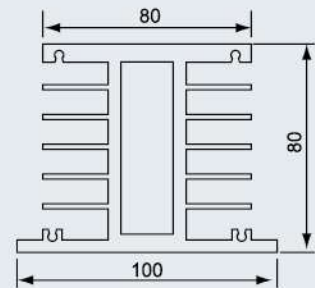

CSR-A03  
(For CTR10A-120A)

CSD-M8  
M8 安装架  
Mounting bracket

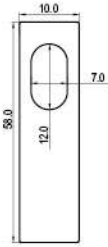

CSD-M8-L  
M8-L 安装架  
Mounting bracket



CSD-M12  
M12 安装架  
Mounting bracket

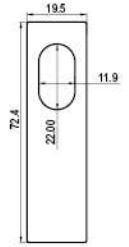

CSD-M12-L  
M12 安装架  
Mounting bracket



CSD-M18  
M18 安装架  
Mounting bracket

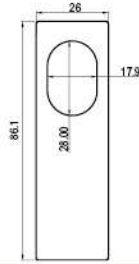

CSD-M18-L  
M18-L 安装架  
Mounting bracket

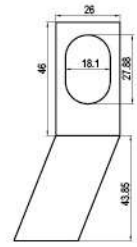

CSD-M30  
M30 安装架  
Mounting bracket

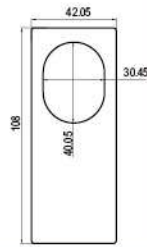

CSD-M30-L  
M30-L 安装架  
Mounting bracket

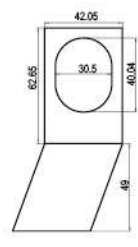

CSD-F18  
18x18 安装架  
Mounting bracket

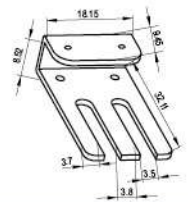

CSD-F25  
25x25 安装架  
Mounting bracket

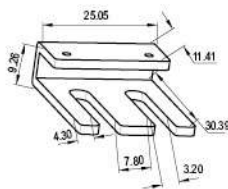

CSD-F30  
30x30 安装架  
Mounting bracket

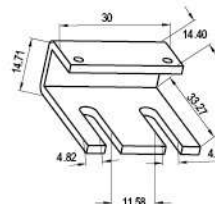

CSD-F40  
40x40 安装架  
Mounting bracket

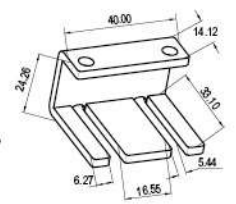

CSD-G50  
CGF50 安装架  
Mounting bracket

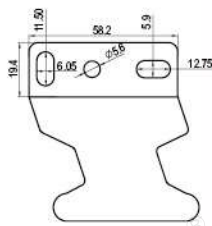

CSD-G70  
CGF70 安装架  
Mounting bracket

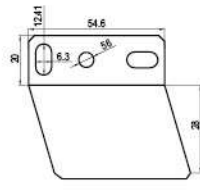

TDE08 标准型反光板  
TD08 高端型反光板  
Mirror



TDE02 标准型反光板  
TD02 高端型反光板  
Mirror



CSD-PS1202/1203/1204  
M12 接插头  
Plug



CSD-PC1202/1203/1204  
M12-L 接插头  
Plug

